

酒匂川流域下水道台帳

施設平面縦断図(図面番号 1)

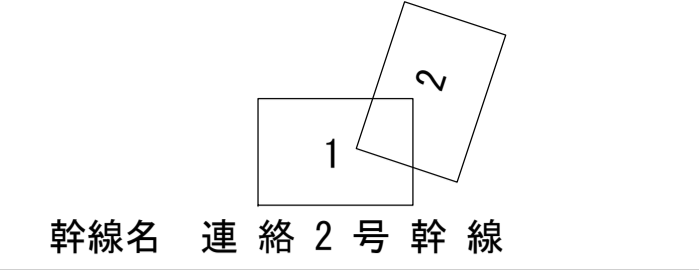

幹線名 連絡2号幹線

1 : 500

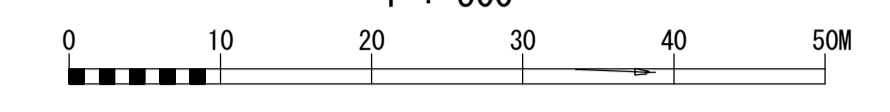

財産区分コード	大分類	中分類	小分類	整理番号
GA	管渠施設	管渠	第工区	

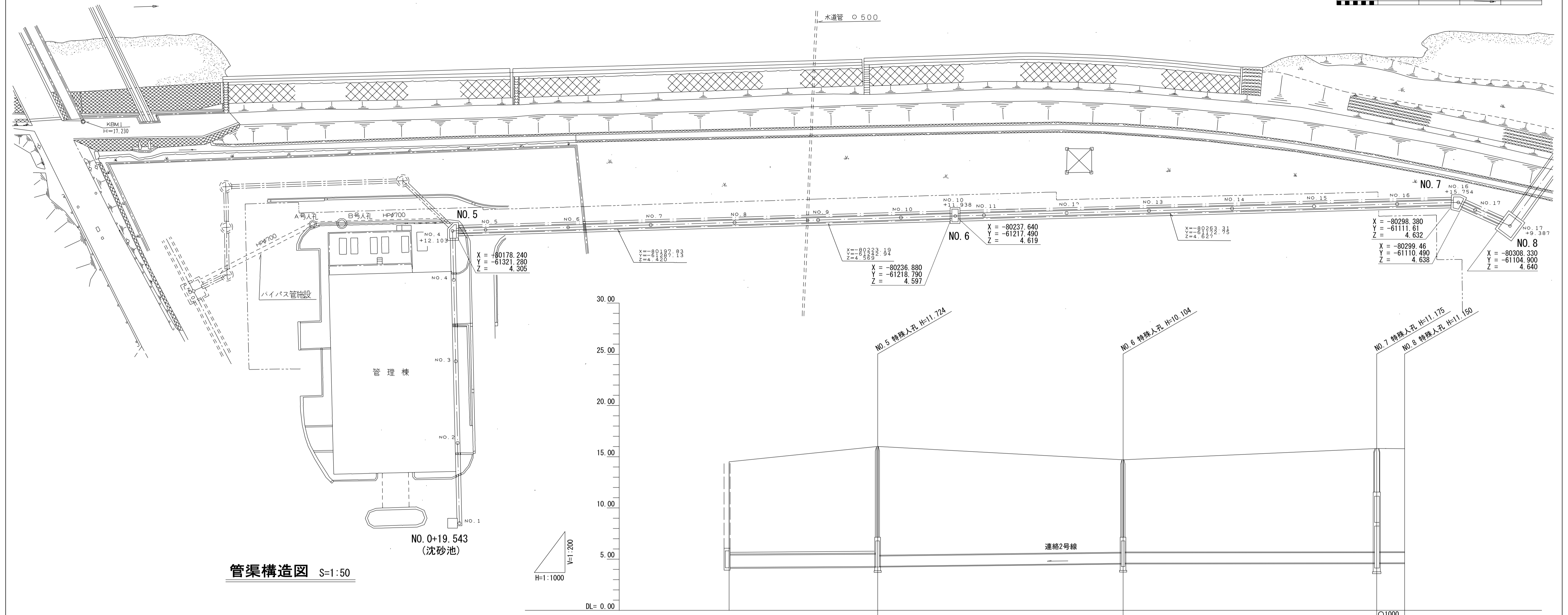

管渠構造図 S=1:50

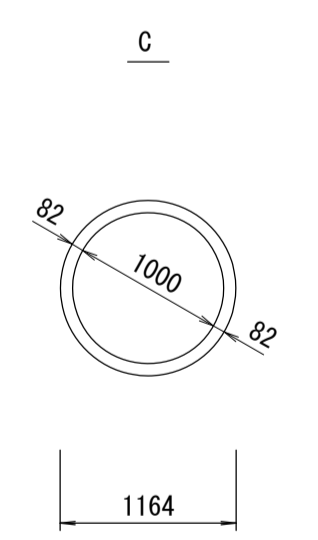

施工区	沈砂池		第101工区(その2)																		
占用区間	C																				
管渠築造	C																				
土被り	(8.800) 8.809	9.228	9.594	9.986	10.224 10.622	10.517	10.250	9.982	9.716	9.449	9.181	9.022 9.000	9.071	9.248	9.424	9.601	9.776	9.954	10.093 10.087	10.081	10.068
地盤高	(14.500) 14.510	14.952	15.341	15.757	16.009 15.923	15.705	15.486	15.268	15.050	14.831	14.701 14.713	14.952	15.130	15.309	15.488	15.666	15.807 15.802	15.802	15.790		
管底高	4.200 4.201	4.224	4.247	4.271	4.285 4.305 4.324	4.373	4.422	4.470	4.519	4.568	4.597 4.619	4.622	4.624	4.626	4.628	4.630	4.632 4.638	4.638	4.640		
追加距離	0.000 0.457	20.457	40.457	60.457	72.580 80.457	100.457	120.457	140.457	160.457	180.457	192.395 200.457	220.457	240.457	260.457	280.457	300.457	316.211 320.457	320.457	328.844		
区間距離	0.000 0.457	20.000	20.000	20.000	12.103 7.897	20.000	20.000	20.000	20.000	20.000	11.938 8.062	20.000	20.000	20.000	20.000	20.000	15.754 4.246	4.246	9.387		
測点	(沈砂池) +19.543 No.1	No.2	No.3	No.4	No.4 +12.103 No.5	No.6	No.7	No.8	No.9	No.10	No.10 +11.938 No.11	No.12	No.13	No.14	No.15	No.16	No.16 +15.754 No.17	No.17	No.17 +9.387		
曲線																					

調整
年月
平成
17
年
3
月
ページ
2

酒匂川流域下水道台帳

施設平面縦断図(図面番号 2)

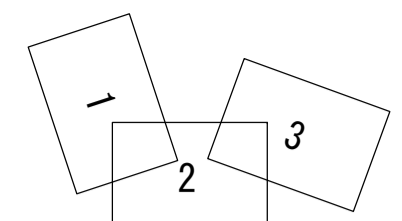

幹線名 連絡2号幹線

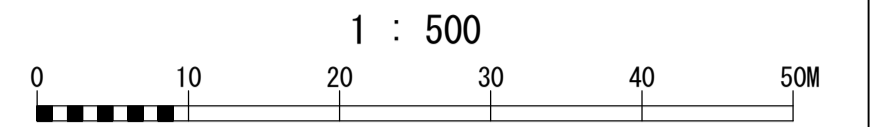

財産区分コード	大分類	中分類	小分類	整理番号
GA	管渠施設	管渠	第工区	

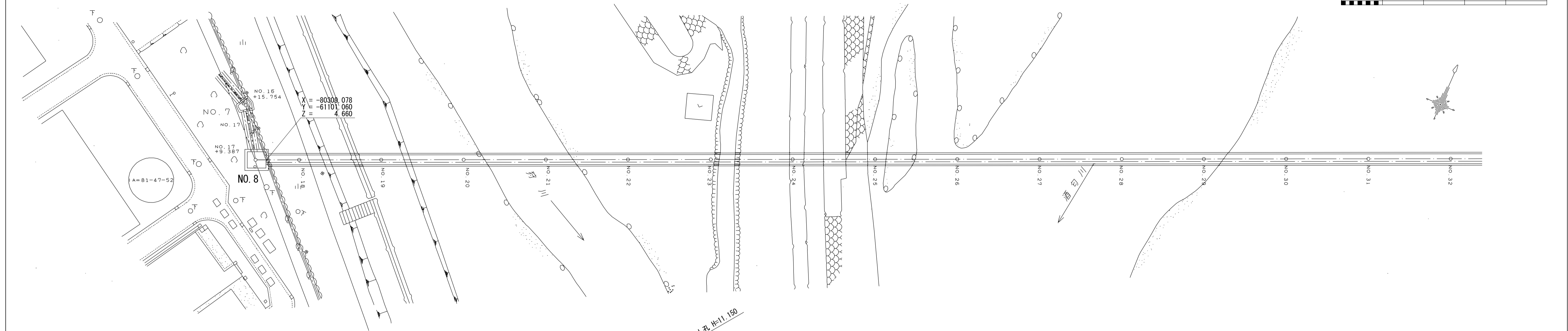

管渠構造図 S=1:50

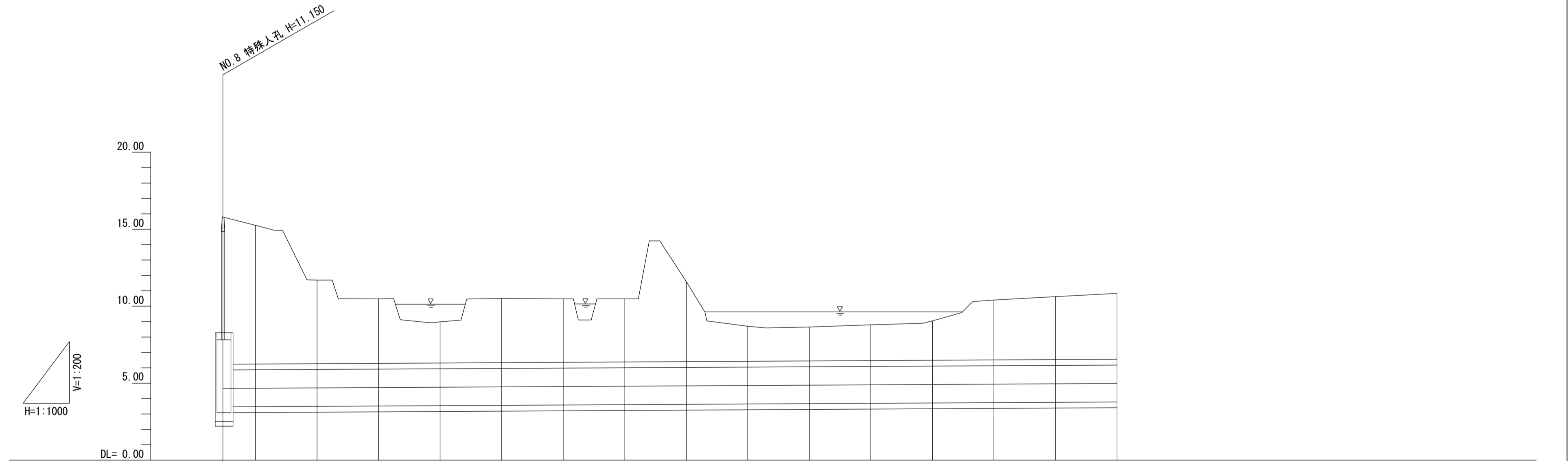
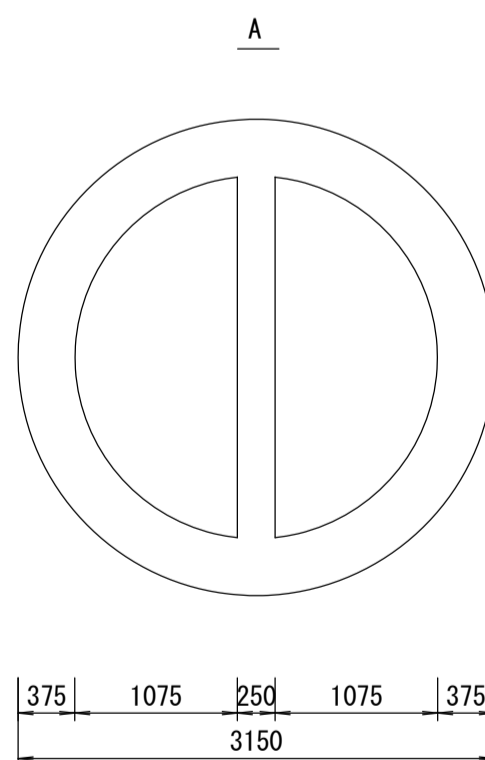

施工工区	第102工区																
占用区間	小田原土木(河川)																
管渠築造	A																
土被り	10.068	9.363	8.819	5.261	4.033	2.535	4.037	4.009	4.002	5.114	2.206	2.148	2.280	2.532	3.874	4.087	4.289
地盤高	15.790	15.250	11.700	10.480	8.990	10.500	10.480	10.480	11.600	8.700	8.650	8.790	9.050	10.400	10.620	10.830	
管底高	4.640	4.660	4.671	4.693	4.715	4.737	4.759	4.781	4.803	4.825	4.847	4.869	4.891	4.913	4.935	4.957	4.979
追加距離	329.844	340.457	360.457	380.457	400.457	420.457	440.457	460.457	480.457	500.457	520.457	540.457	560.457	580.457	600.457	620.457	
区間距離	9.387	10.613	20.000	20.000	20.000	20.000	20.000	20.000	20.000	20.000	20.000	20.000	20.000	20.000	20.000	20.000	
測点	No.17 +9.387	No.18	No.19	No.20	No.21	No.22	No.23	No.24	No.25	No.26	No.27	No.28	No.29	No.30	No.31	No.32	
曲線	1A=81°47'52"																

酒匂川流域下水道台帳

施設平面縦断図(図面番号 3)

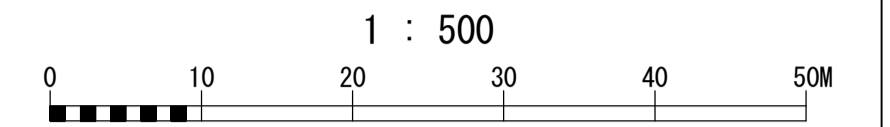
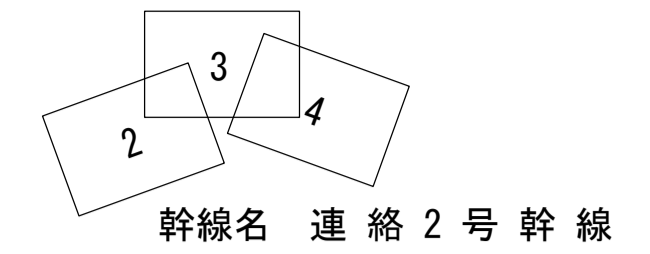

財産区分コード	大分類	中分類	小分類	整理番号
GA	管渠施設	管渠	第 工区	

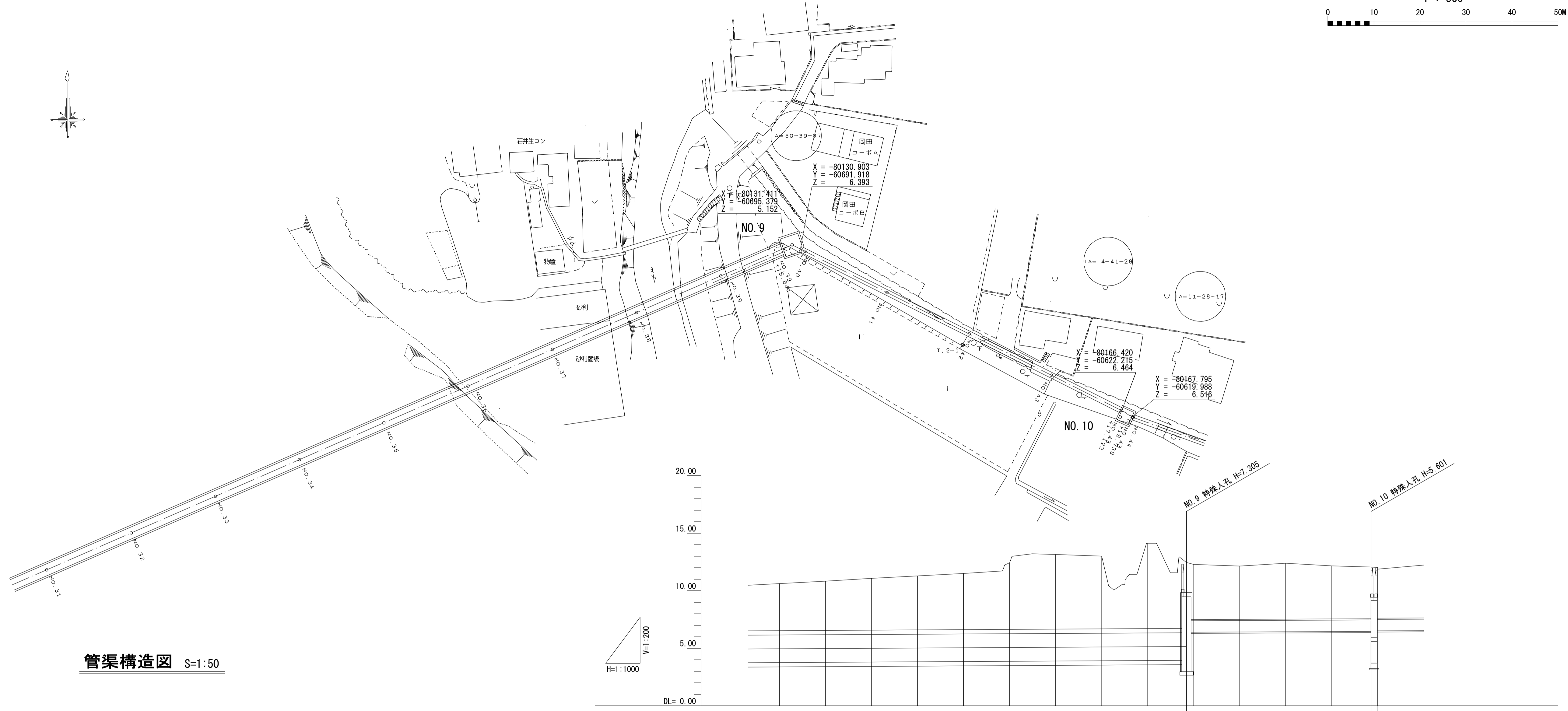

管渠構造図 S=1:50

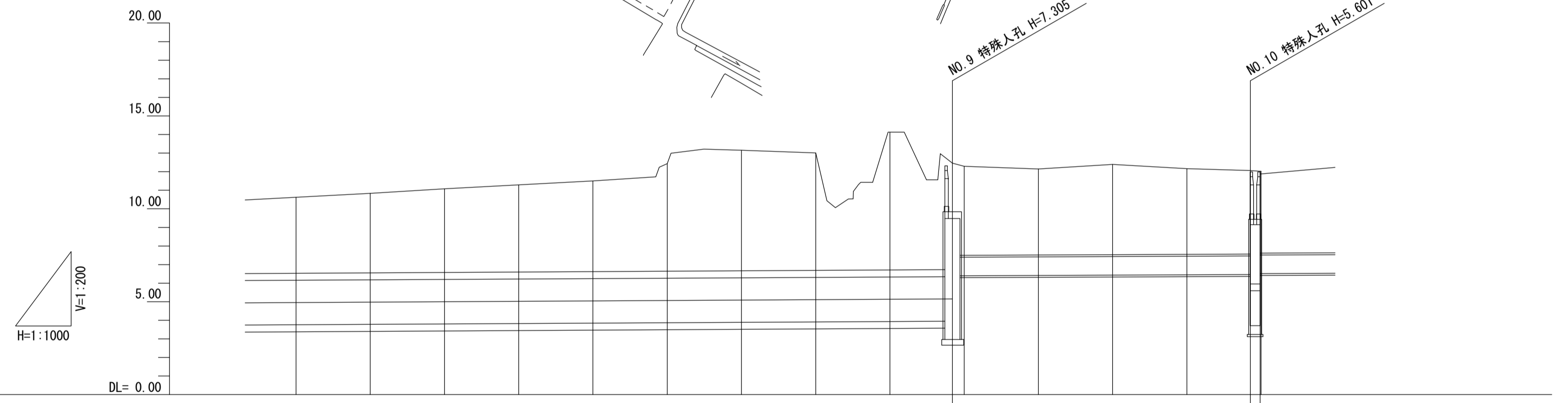
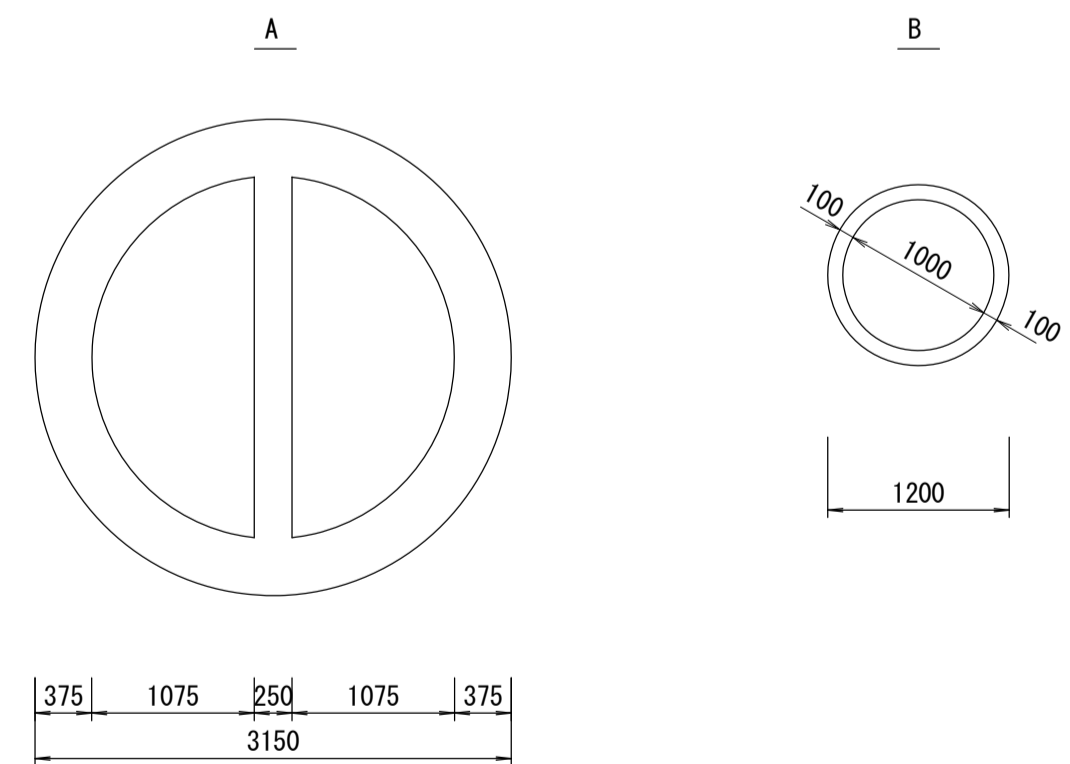

施工工区	第102工区										第103-1工区			
占用区間	小田原土木(河川)										小田原市			
管渠築造	A										B			
土被り	4.087	4.289	4.531	4.733	4.935	5.137	5.339	5.541	5.743	5.945	4.637	4.839	5.041	5.243
地盤高	10.620	10.830	11.080	11.290	11.500	12.430	13.150	13.010	14.130	12.457	12.150	12.390	12.160	12.065
管底高	4.957	4.979	5.001	5.023	5.045	5.067	5.089	5.111	5.133	5.152	6.413	6.431	6.449	6.464
追加距離	600.457	620.457	640.457	660.457	680.457	700.457	720.457	740.457	760.457	777.298	800.457	820.457	840.457	857.570
区間距離	20.000	20.000	20.000	20.000	20.000	20.000	20.000	20.000	20.000	16.841	20.000	20.000	20.000	17.122
測点	No. 31	No. 32	No. 33	No. 34	No. 35	No. 36	No. 37	No. 38	No. 39	No. 39 No. 40 No. 41	No. 41	No. 42	No. 43	No. 43 No. 44 No. 44
曲線											1A=50° 39' 07"		1A=4° 41' 28"	

酒匂川流域下水道台帳

施設平面縦断図(図面番号 4)

財産区分コード	大分類	中分類	小分類	整理番号
GA	管渠施設	管渠	第工区	

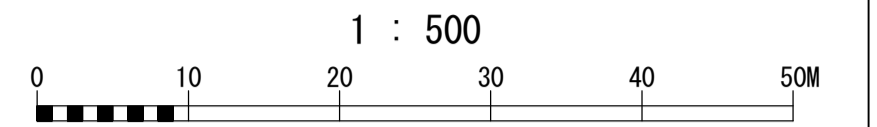
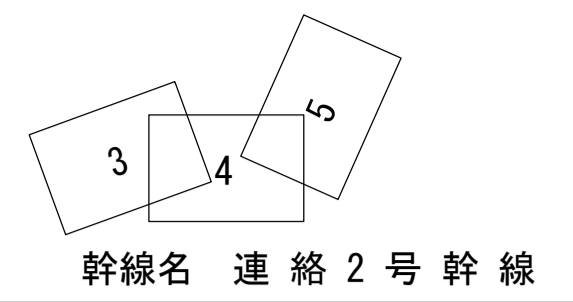

管渠構造図 S=1:50

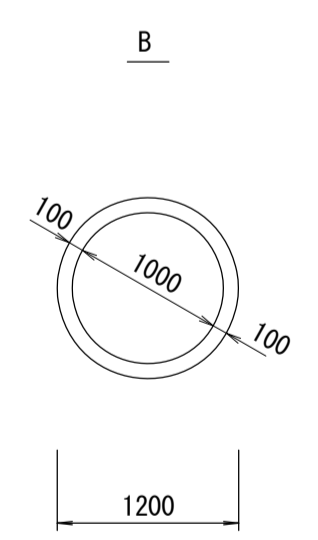

施工区	第103-1工区					第103-2-1工区					第103-2-2工区					第104-1工区																			
占用区間	小田原市					小田原松田線					小田原市					国道255号線																			
管渠築造	B																																		
土被り	4.501	4.501	4.722	4.501	4.259	4.218	4.207	4.236	4.077	3.831	3.741	3.706	3.680	3.659	3.600	3.599	3.519	3.476	3.438	3.499	3.494	3.475	3.331	3.246	3.142	3.037	3.028	3.010	2.993	2.963	3.649	3.871	3.808	4.053	4.203
地盤高	12.065	12.020	12.360	12.160	11.940	11.920	11.930	11.971	11.730	11.650	11.620	11.600	11.582	11.582	11.530	11.530	11.460	11.420	11.500	11.511	11.511	11.380	11.330	11.330	11.260	11.160	11.190	11.180	11.175	11.160	11.150	11.870	12.100	12.360	12.530
管底高	6.464	6.516	6.538	6.559	6.581	6.602	6.623	6.635	6.794	6.809	6.814	6.820	6.823	6.823	6.830	6.831	6.841	6.844	6.882	6.901	6.917	6.936	6.949	6.984	7.018	7.053	7.062	7.065	7.067	7.087	7.121	7.129	7.192	7.207	7.227
追加距離	857.579	860.457	880.457	900.457	920.457	940.457	960.457	971.289	990.457	1000.457	1009.896	1020.457	1025.679	1040.457	1041.461	1060.457	1066.337	1080.457	1092.649	1100.457	1120.457	1140.457	1160.457	1180.457	1200.457	1160.457	1166.343	1167.628	1168.913	1180.457	1200.457	1204.967	1220.457	1240.457	
区間距離	17.172	0.261	20.000	20.000	20.000	20.000	20.000	10.832	9.168	20.000	9.439	10.561	5.222	14.778	1.004	18.996	5.880	14.120	12.192	7.808	20.000	20.000	20.000	20.000	20.000	5.886	1.285	1.285	11.544	20.000	4.510	15.490	20.000		
測点	No.43 +17.129 No.44	No.45	No.46	No.47	No.48	No.49	No.49 +10.832	No.50	No.51	BC.1	No.52	SP.1	No.53 EC.1	No.54 No.54 +5.880	No.55	No.55 +12.192	No.56	No.57	No.58	No.59 BC.2 SP.2 EC.2	No.60	No.61 +4.510	No.62	No.63											
曲線	IA=4° 41' 28"		IA=11° 28' 17"			IA=3° 37' 38"					IP.1 IA=9-2-33 R=200.000 TL=15.815 CL=31.565 SL=0.624		IA=93° 04' 47"		IA=93° 14' 27"		IP.2 IA=0-58-54 R=150.000 TL=1.285 CL=2.570 SL=0.006					IA=70° 27' 48"													

酒匂川流域下水道台帳

施設平面縦断図(図面番号 5)

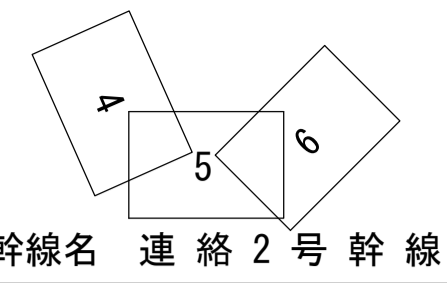

幹線名 連絡2号幹線

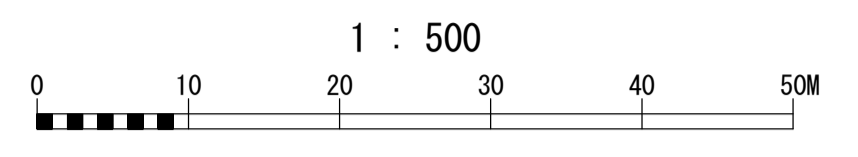

財産区分コード	大分類	中分類	小分類	整理番号
GA	管渠施設	管渠	第工区	

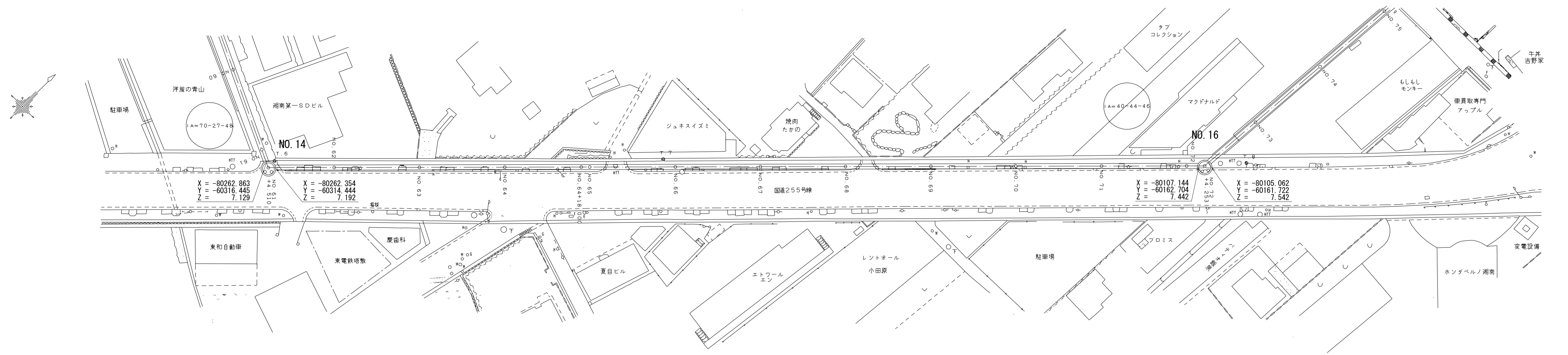

管渠構造図 S=1:50

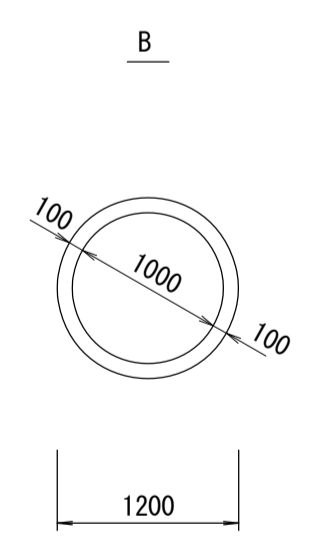
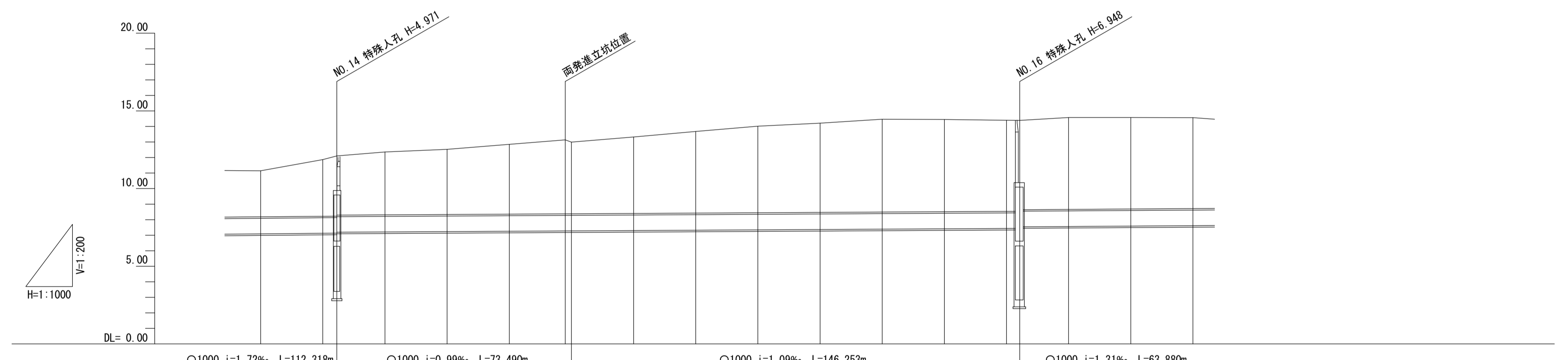

施工区	第103-2-2工区		第104-1工区				第104-2工区				第105-1工区										
占用区間	小田原市		国道255号線				小田原市				小田原市										
管渠築造	B																				
土被り	2.963	3.649	3.871	3.808	4.053	4.203	4.503	4.775	4.608	4.914	5.252	5.570	5.738	5.976	5.935	5.863	5.848	5.748	5.917	5.891	5.855
地盤高	11.150	11.970	12.100	12.360	12.530	12.850	13.140	12.990	13.320	13.680	14.020	14.210	14.470	14.450	14.400	14.390	14.580	14.580	14.580	14.580	14.570
管底高	7.087	7.131	7.129	7.182	7.207	7.227	7.247	7.265	7.284	7.306	7.328	7.350	7.372	7.394	7.415	7.437	7.442	7.542	7.563	7.589	7.615
追加距離	1180.457	1200.457	1204.967	1220.457	1240.457	1260.457	1278.457	1280.457	1300.457	1320.457	1340.457	1360.457	1380.457	1400.457	1420.457	1424.710	1440.457	1460.457	1480.457	1480.457	1480.457
区間距離	11.544	20.000	4.510	15.490	20.000	20.000	18.000	2.000	20.000	20.000	20.000	20.000	20.000	20.000	20.000	4.253	15.747	20.000	20.000	20.000	20.000
測点	No.60	No.61 +4.510	No.62	No.63	No.64	No.64	No.65 +18.000	No.65	No.66	No.67	No.68	No.69	No.70	No.71	No.72 +4.253	No.72	No.73	No.74	No.75	No.75	No.75
曲線	IA=70° 27' 48"										IA=40° 44' 46"										

酒匂川流域下水道台帳

施設平面縦断図(図面番号 6)

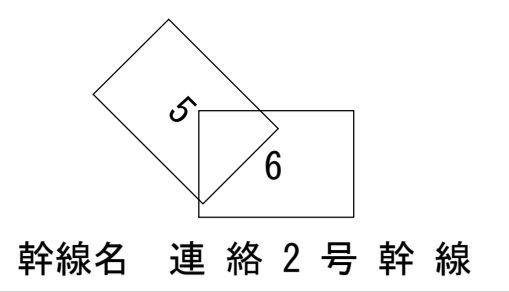

財産区分コード	大分類	中分類	小分類	整理番号
GA	管渠施設	管渠	第工区	

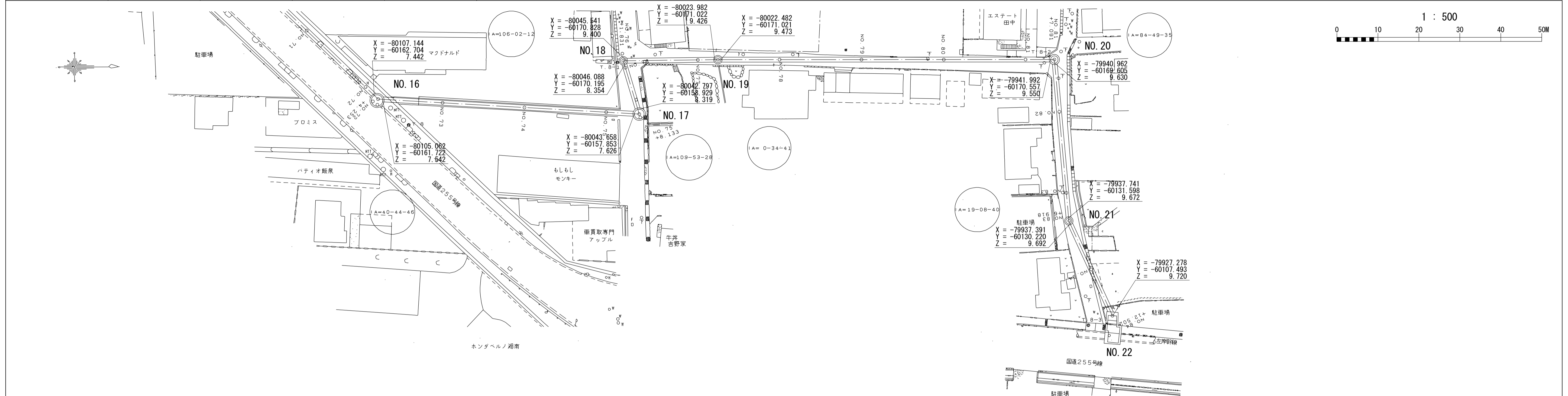

管渠構造図 S=1:50

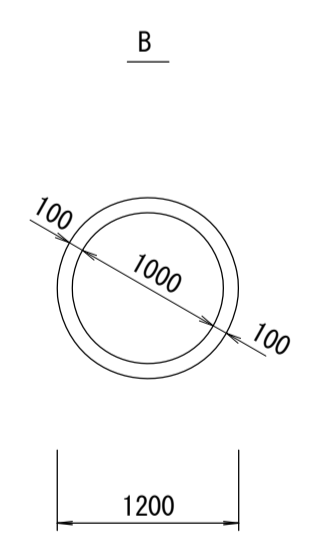
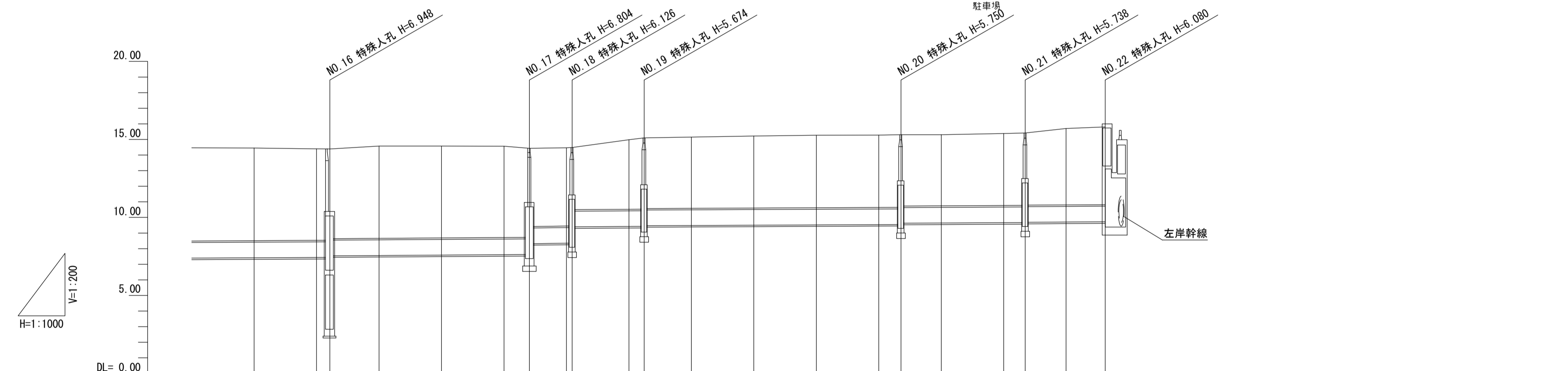

施工区	第104-2工区				第105-1工区				第105-2工区		第105-3工区					
占用区間	国道255号線				小田原市				国道255号線							
管渠築造	B															
土被り	5.935	5.833	5.748	5.917	5.891	5.855	5.704	5.021	4.490	4.614	4.645	4.637	4.615	4.638	4.894	4.980
地盤高	14.450	14.400	14.390	14.580	14.580	14.570	14.430	14.470	14.980	15.220	15.270	15.280	15.380	15.410	15.700	15.800
管底高	7.415	7.457	7.542	7.563	7.589	7.615	7.626	8.349	8.420	9.506	9.525	9.543	9.665	9.672	9.706	9.720
追加距離	1400.457	1420.457	1424.710	1440.457	1460.457	1480.457	1488.590	1500.457	1520.457	1560.457	1580.457	1600.457	1640.457	1647.375	1660.457	1672.959
区間距離	20.000	20.000	4.253	15.747	20.000	20.000	8.133	11.867	18.169	20.000	20.000	20.000	7.091	6.918	13.082	12.502
測点	No. 71	No. 72 +4.253	No. 73	No. 74	No. 75	No. 75 +8.133	No. 76 +1.831	No. 77 +4.800	No. 78	No. 79	No. 80	No. 81 +7.091	No. 82	No. 83 +6.918	No. 84	No. 84 +12.502
曲線	IA=40° 44' 46"				IA=109° 53' 28" IA=106° 02' 12" IA=0° 34' 41"				IA=84° 49' 35"		IA=19° 08' 40"					